

mectron

 **MECTRON**
PIEZOSURGERY® INSERTS

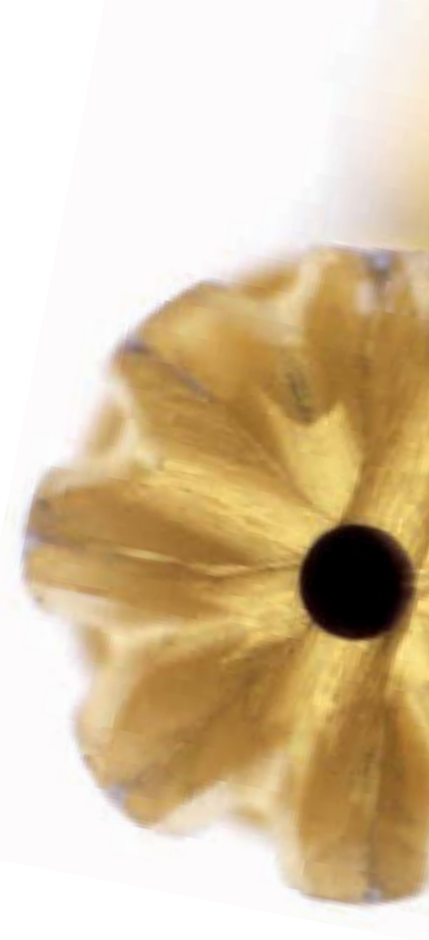

→ THE ORIGINAL
PIEZOELECTRIC BONE SURGERY –
EVIDENCE BASED!



4	PIEZOSURGERY® Technique	27	PINS IM1 AL, 2-2.4 AL, 2-3 AL	49	Insert OT5 - OT5A - OT5B	70	Insert EN3
6	Insert quality	28	Insert IM2A - IM2A-15	50	Insert OT6	71	Insert EN4
8	Indications	29	Insert IM2P - IM2P-15	51	Insert OT7 - OT7A	72	Insert EN5R
10	Basic Kit	30	Insert IM3A - IM3A-15	52	Insert OT7S-4	73	Insert EN5L
11	Sinus Lift Kit	31	Insert IM3P - IM3P-15	53	Insert OT7S-3	74	Insert EN6R
12	Implant Prep Kit	32	Insert IM4A	54	Insert OT7-20	75	Insert EN6L
13	Implant Prep Kit Pro	33	Insert IM4P	55	Insert OT8R - OT8L	76	Insert EX1
14	Implant Prep Kit Starter	34	Insert P2-3	56	Insert OT9	77	Insert EX2 - EX3
15	Mini Implant Prep Kit	35	Insert P3-4	58	Insert OP1	78	Insert PS1
16	Osteotomy Kit	36	Bone Expanders	59	Insert OP2	79	Insert PS2
17	Periodontal Kit	38	Sinus Physiolift®	60	Insert OP3 - OP3A	80	Insert PS6
18	Extraction Kit	40	Insert IM1 SP	61	Insert OP4	81	Insert PP1
19	Retro Surgical Kit	41	Insert MDI 1.9	62	Insert OP5	82	Insert PP10
20	Bone Expander Kits	42	Insert MDI 2.2	63	Insert OP6 - OP6A	83	Insert PP11-PP12
21	Sinus Physiolift® Kits	43	Insert MDI 2.5	64	Insert OP7	84	Tipholder ICP, tip IC1
22	PIEZOSURGERY® insert box	44	Insert OT1	65	Insert EL1	85	Crown prep tips
23	Insert Tray	45	Insert OT1A	66	Insert EL2	86	Enzymec
24	Insert IM1S	46	Insert OT2	67	Insert EL3	88	Science
25	PINS IM1, IM1S, 2-2.4, 2-3	47	Insert OT3	68	Insert EN1	90	Spare Parts
26	Insert IM1 AL	48	Insert OT4	69	Insert EN2	92	Reference Numbers

PIEZOSURGERY® TECHNIQUE

PIEZOSURGERY® HAS DEFINED A NEW DIMENSION IN BONE SURGERY

- It's simple, stress-free and selective
- It increases the quality and success for you and your patients





Thanks to the controlled sophisticated ultrasound vibrations, the original PIEZOSURGERY® technique opens up a new age for osteotomy, osteoplasty and extraction in Implantology, Periodontology, Endodontics and Surgical Orthodontics.

- MICROMETRIC CUTS: maximum surgical precision and intra-operative sensitivity
- SELECTIVE CUTS: minimal damage to soft tissue, maximum safety for you and your patients
- CAVITATION EFFECT: maximum intra-operative visibility and a blood-free surgical site
- HISTOLOGICAL ADVANTAGE: more favorable bone healing in osseointegration process

→ INSERT QUALITY



→ PRECISION

A CNC controlled 5-dimensional sharpening machine cuts with an accuracy of up to $0.1 \mu\text{m}$. The whole cutting process for a single insert last up to 12 min.

→ MATERIAL

mectron ultrasound inserts are build with medical grade, high quality, stainless steel.



→ HIGH END INSERTS FOR PROFESSIONALS

Each mectron ultrasound insert will pass through 12 working steps.



→ DIAMOND COATING

Depending on the indication, the inserts are coated with specially selected diamonds. The granulometry of the diamond coating is adapted to the respective treatment.



→ TITANIUM NITRIDE COATING

A coating of titanium nitride, applied to inserts which treat bone, increases the hardness of the surface, avoids corrosion and therefore increases working life.



→ LABELING

Each insert is labeled gently by a laser.

→ QUALITY CHECK

Each insert is checked in detail before getting an OK for the sales.

INDICATIONS

→ SINUS LIFT TECHNIQUE CRESTAL APPROACH

→ STANDARD

IM1 SP

IM2P

OT9

CS1

PIN IM1

PIN 2-2.4

→ SINUS LIFT TECHNIQUE LATERAL APPROACH

→ STANDARD

OP3

OT1

EL1

→ OPTIONAL

OT1A

OT5

OT5A

OT5B

EL2

EL3

→ IMPLANT SITE PREPARATION

→ STANDARD

IM1S

IM2A

IM3A

IM4A

IM2P

IM3P

IM4P

OT4

P2-3

P3-4

→ OPTIONAL

IM1 AL

IM2A-15

IM3A-15

IM2P-15

IM3P-15

PINS

→ MINI DENTAL IMPLANT SITE PREPARATION

→ STANDARD

IM1S

MDI 1.9

MDI 2.2

MDI 2.5

→ RIDGE EXPANSION

→ STANDARD

OT7

OT4

OP5

→ OPTIONAL

OT2

OT7A

OT7S-4

OT7S-3

OT7-20

BONE EXPANDERS

→ EXTRACTIONS

→ STANDARD

EX1

EX2

EX3

PS2

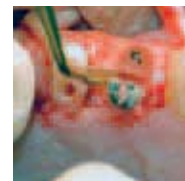
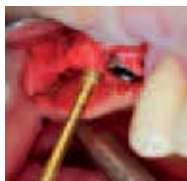

→ BONE BLOCK GRAFTING	→ BONE CHIP GRAFTING/BONE MODELING	→ ENDODONTICS	→ OSTEOTOMY CLOSE TO NERVES	→ CORTICOTOMY TECHNIQUE	→ PERIODONTAL SURGERY	
→ STANDARD	→ STANDARD	→ STANDARD	→ STANDARD	→ STANDARD	→ STANDARD	→ OPTIONAL
OT7	OP3	OP7	OT1	OT2	PS2	PS1
OP5	OP1	PS 2	OT5	OT7	OP5	PS6
OT8R	→ OPTIONAL	EN1	→ OPTIONAL	OT7A	OP3	PP10
OT8L	OP2	EN2	OT9	OT7S-4	PP1	PP11
→ OPTIONAL	OP3A	EN3		OT7S-3		PP12
OT6		EN4		OT7-20		OP2
OT7A		→ OPTIONAL				OP3A
OT7S-4		EN5R				OP4
OT7S-3		EN5L				OP6
OT7-20		EN6R				OP6A
		EN6L				ICP+IC1
		OP3				

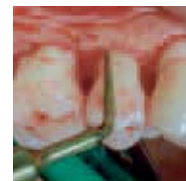

→ BASIC KIT

→ EQUIPPED WITH:

- 1 insert OT7
- 1 insert OT2
- 1 insert EX1
- 1 insert OP1
- 1 insert OP3
- 1 insert tray



→ OT7 → OT2 → EX1 → OP1 → OP3

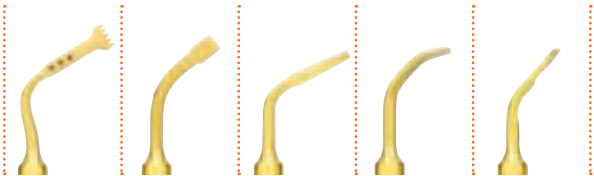

→ SINUS LIFT KIT

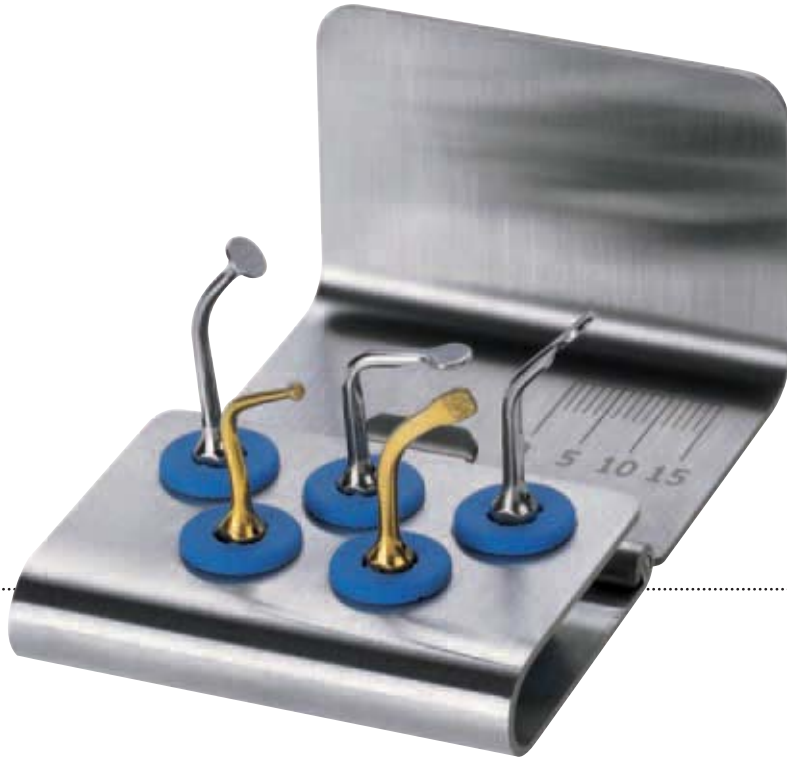

→ EQUIPPED WITH:

- 1 insert OT1
- 1 insert OT5
- 1 insert EL1
- 1 insert EL2
- 1 insert EL3
- 1 insert tray

→ OT1 → OT5 → EL1 → EL2 → EL3



→ IMPLANT PREP KIT

→ EQUIPPED WITH:

- 1 insert IM1S
- 1 insert IM2A
- 1 insert IM2P
- 1 insert IM3A
- 1 insert IM3P
- 1 insert OT4
- 1 implant insert tray



→ IM1S → IM2A → IM2P → IM3A → IM3P → OT4

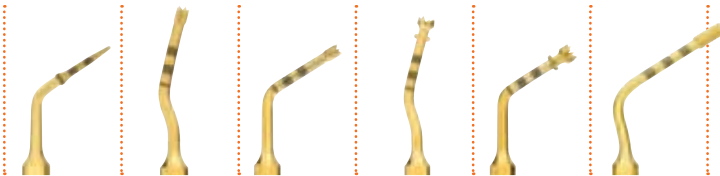



IMPLANT PREP KIT PRO



→ EQUIPPED WITH:

- 1 insert IM1S
- 1 insert IM2A
- 1 insert IM2P
- 1 insert IM3A
- 1 insert IM3P
- 1 insert OT4
- 1 insert IM4A
- 1 insert IM4P
- 1 insert P2-3
- 1 insert P3-4
- 3 pins IM1S
- 3 pins 2-2.4
- 1 implant insert tray

→ IM1S → IM2A → IM2P → IM3A → IM3P → OT4 → IM4A → IM4P → P2-3 → P3-4 → PIN IM1S → PIN 2-2.4

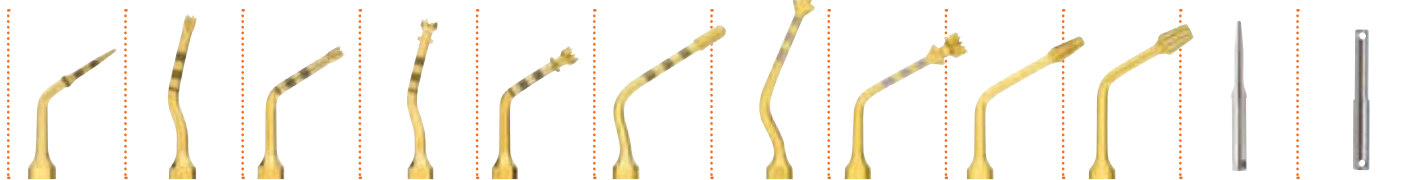

→ IMPLANT PREP KIT STARTER

→ EQUIPPED WITH:

- 1 insert IM1S
- 1 insert IM2P
- 1 insert IM3P
- 1 insert OT4
- 1 insert P2-3
- 1 insert tray



→ IM1S → IM2P → IM3P → OT4 → P2-3

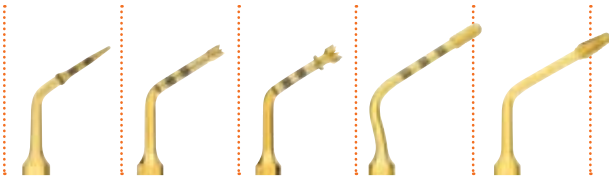

→ MINI IMPLANT PREP KIT



→ EQUIPPED WITH:

- 1 insert IM1S
- 1 insert MDI 1.9
- 1 insert MDI 2.2
- 1 insert MDI 2.5
- 1 insert tray

→ IM1S → MDI 1.9 → MDI 2.2 → MDI 2.5

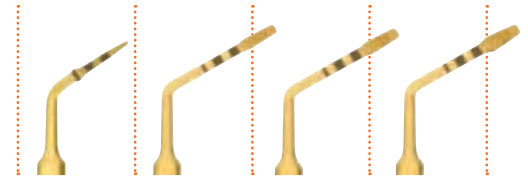

→ OSTEOTOMY KIT

→ EQUIPPED WITH:

- 1 insert OT7
- 1 insert OT7S-4
- 1 insert OT7S-3
- 1 insert OT8R
- 1 insert OT8L
- 1 insert tray



→ OT7 → OT7S-4 → OT7S-3 → OT8R → OT8L

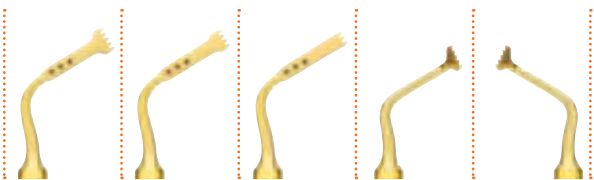

→ PERIODONTAL KIT

→ EQUIPPED WITH:

- 1 insert PS2
- 1 insert OP5
- 1 insert PP1
- 1 insert OP3
- 1 insert OP3A
- 1 insert tray

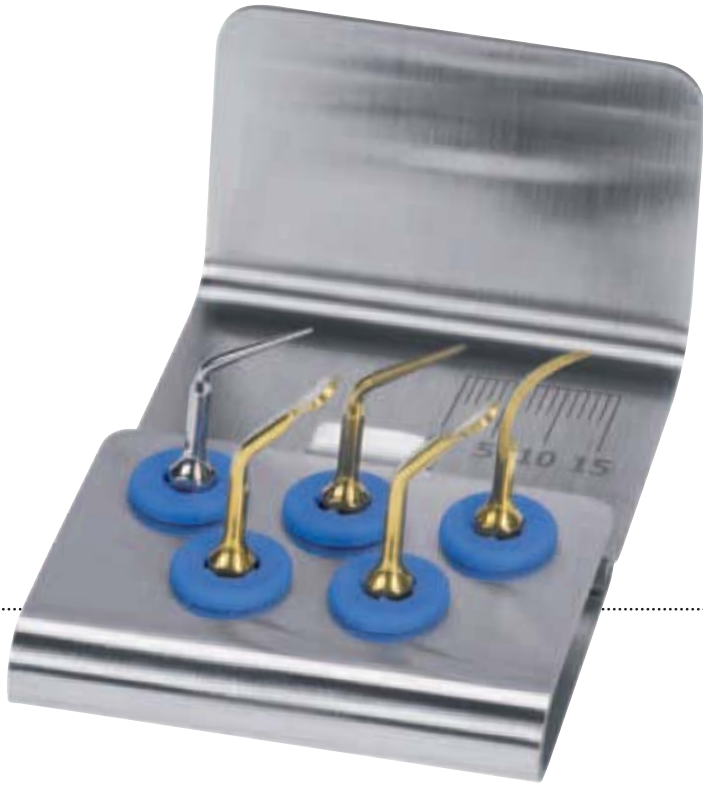

→ PS2 → OP5 → PP1 → OP3 → OP3A



→ EXTRACTION KIT

→ EQUIPPED WITH:

- 1 insert EX1
- 1 insert EX2
- 1 insert EX3
- 1 insert PS2
- 1 insert PS6
- 1 insert tray



→ EX1 → EX2 → EX3 → PS2 → PS6



→ RETRO SURGICAL KIT



→ EQUIPPED WITH:

- 1 insert OP7
- 1 insert EN1
- 1 insert EN3
- 1 insert EN5R
- 1 insert EN5L
- 1 insert tray

→ OP7 → EN1 → EN3 → EN5R → EN5L

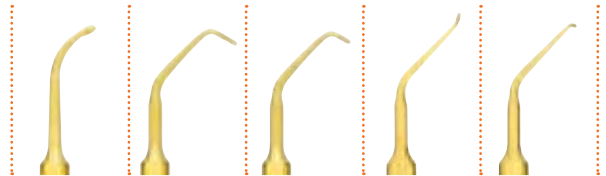

→ BONE EXPANDER KITS

BONE EXPANDER KIT

→ EQUIPPED WITH:

- 1 expander of each type
- 1 ADM8
- 1 bone expander tray



BONE EXPANDER KIT PRO

→ EQUIPPED WITH:

- 1 expander of each type
- 1 ADM8, 1 ADR16, 1 ADR7
- 1 ratchet
- 1 bone expander tray



BONE EXPANDER KIT PRO S

→ EQUIPPED WITH:

- 2 expanders of each type
- 1 ADM8, 1 ADR16, 1 ADR7
- 1 ratchet
- 1 bone expander tray



→ 2.5x11.5 → 3.5x11.5 → 4.5x11.5 → 2.5x15 → 3.5x15 → 4.5x15 → ADM8 → ADR16 → ADR7 → RATCHET



→ SINUS PHYSIOLIFT® KITS

SINUS PHYSIOLIFT® BASIC KIT

→ EQUIPPED WITH:

- 2 crestal sinus elevators CS1
- pressure control system: Physiolifter
- micromotor and ratchet adapters: ADM10, ADR10
- ratchet
- 3 silicone tubes with tube-tube connector
- 2 complete sealed tubes
- 3 sterile disposable syringes
- 2 insert trays

SINUS PHYSIOLIFT® PRO KIT

→ EQUIPPED WITH:

- PIEZOSURGERY® inserts: IM1 SP, IM2P, OT9
- alignment pins: PIN IM1, PIN 2-2.4
- 2 crestal sinus elevators CS1
- pressure control system: Physiolifter
- micromotor and ratchet adapters: ADM10, ADR10
- ratchet
- 3 silicone tubes with tube-tube connector
- 2 complete sealed tubes
- 3 sterile disposable syringes
- 2 insert trays

→ CS1 → PHYSIOLIFTER → ADR10 → ADM10 → RATCHET → PLUG → SYRINGE → IM1 SP → PIN IM1 → IM2P → PIN 2-2.4 → OT9



PIEZOSURGERY® INSERT BOX



- fully autoclavable
- perfect storage of all PIEZOSURGERY® inserts
- light, easy to use, compact and roomy

→ INSERT TRAY

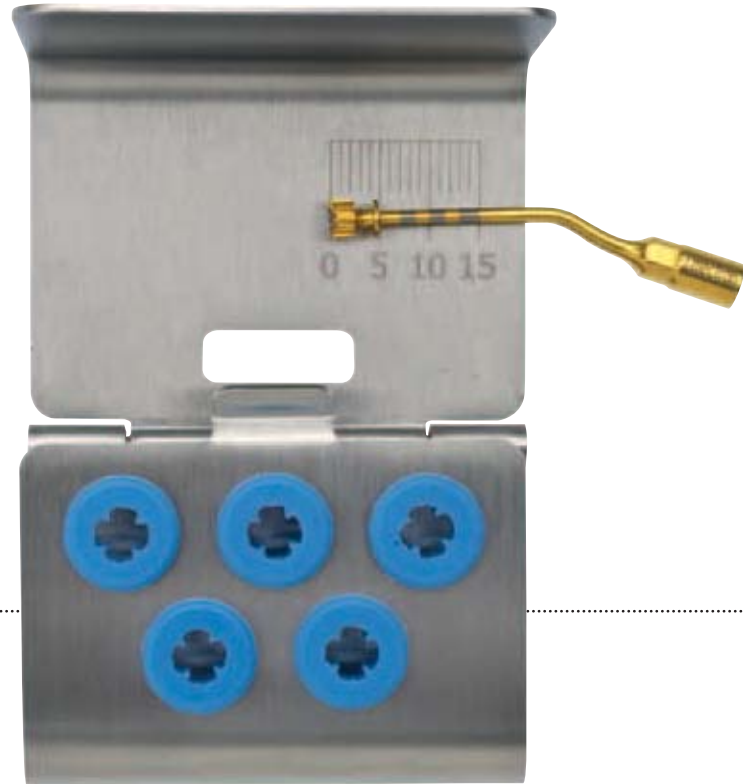

- stainless steel tray with depth markings
- for sterilisation and storage

→ CUTTING ACTION

bone perforation

→ CLINICAL APPLICATION

initial pilot osteotomy
(in the maxilla)

→ MODE

PIEZOSURGERY® *touch*
Special

PIEZOSURGERY® 3
Bone

PIEZOSURGERY® II
Bone

PIEZOSURGERY®
Boosted

→ POWER

Special

Special

C



diamond grain size 30 µm

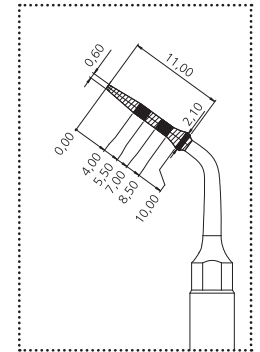

alignment pins

→ PINS IM1, IM1S, 2-2.4, 2-3

→ DESCRIPTION

alignment pins, dedicated to
IM1S, IM2 ($\varnothing 2$), IM3 ($\varnothing 3$), OT4 ($\varnothing 2.4$), IM1 SP

→ CLINICAL APPLICATION

to check preparation axis alignment

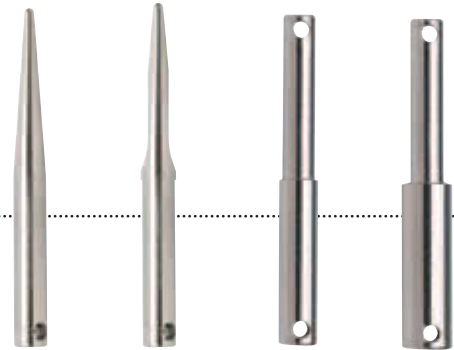
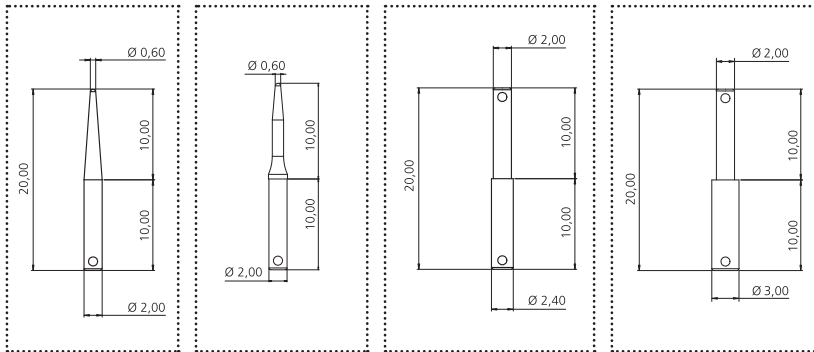

→ PIN IM1

→ PIN IM1S

→ PIN 2-2.4

→ PIN 2-3

→ CUTTING ACTION

bone perforation

→ CLINICAL APPLICATION

initial pilot osteotomy in extraction sites

→ MODE

→ POWER

PIEZOSURGERY® *touch*

Implant

PIEZOSURGERY® 3

Implant

Implant

PIEZOSURGERY® II

Bone

1

PIEZOSURGERY®

Boosted

C

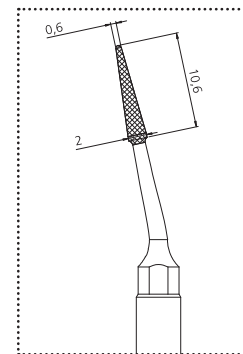
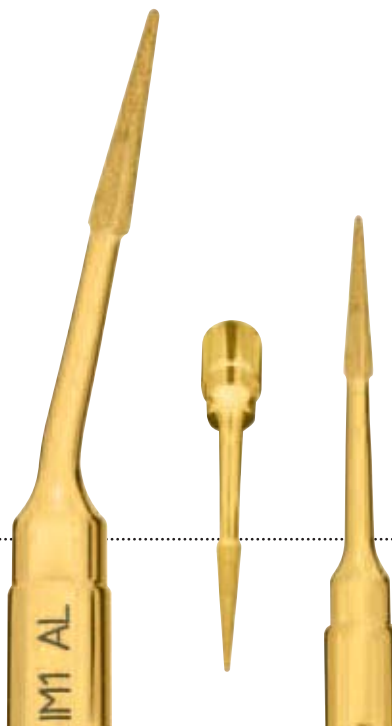

diamond grain size 30 µm

→ ALVEOLAR PINS IM1 AL, 2-2.4 AL, 2-3 AL

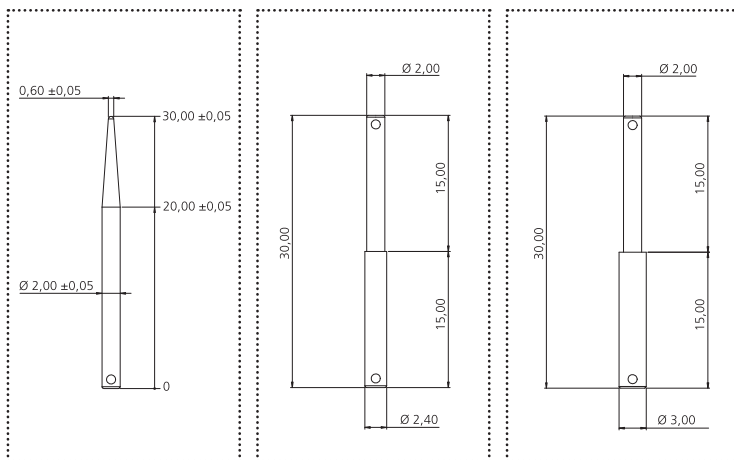

→ DESCRIPTION

30 mm alignment pins, for extraction sites dedicated to IM1 AL, IM2A ($\varnothing 2$), OT4 ($\varnothing 2.4$), IM3A ($\varnothing 3$)

→ CLINICAL APPLICATION

to check preparation axis alignment

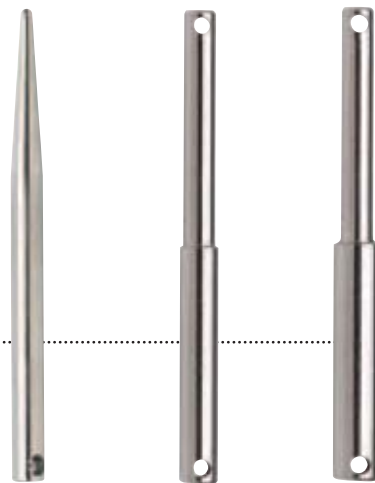

→ PIN IM1 AL

→ PIN 2-2.4 AL

→ PIN 2-3 AL

IM2A – IM2A-15

2 mm Ø implant site preparation insert

→ CUTTING ACTION

bone perforation

→ CLINICAL APPLICATION

pilot osteotomy in anterior region
(in the maxilla)

→ MODE

PIEZOSURGERY® *touch*

Implant

PIEZOSURGERY® 3

Implant

PIEZOSURGERY® II

Bone

PIEZOSURGERY®

Boosted

→ POWER

Implant

1

C

IM2A-15

length: 15 mm

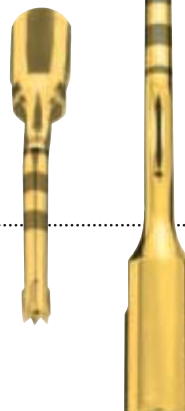
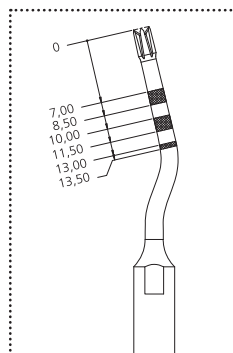

2 mm Ø implant site preparation insert

IM2P – IM2P-15

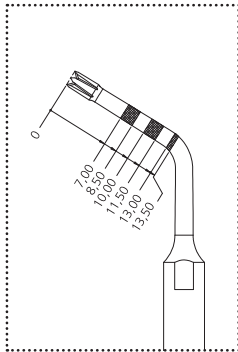

→ CUTTING ACTION

bone perforation

→ CLINICAL APPLICATION

pilot osteotomy in posterior region
(in the maxilla)

→ MODE

→ POWER

PIEZOSURGERY® *touch*
Implant

PIEZOSURGERY® 3
Implant Implant

PIEZOSURGERY® II
Bone 1

PIEZOSURGERY®
Boosted C



IM3A – IM3A-15

3 mm Ø implant site preparation insert

→ CUTTING ACTION

bone perforation

→ CLINICAL APPLICATION

to enlarge or to finalize the implant site preparation; insert with double irrigation to avoid overheating (in the maxilla)

→ MODE

PIEZOSURGERY® *touch*

Implant

PIEZOSURGERY® 3

Implant

PIEZOSURGERY® II

Bone

PIEZOSURGERY®

Boosted

→ POWER

Implant

1

C

IM3A-15

length: 15 mm

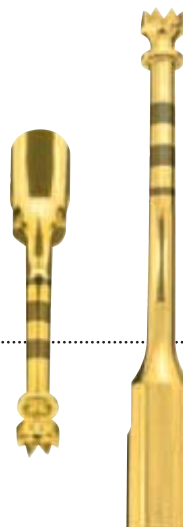
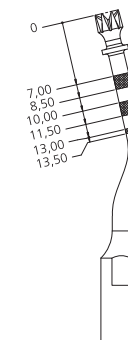

3 mm Ø implant site preparation insert

IM3P – IM3P-15

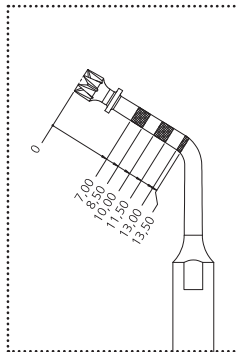

→ CUTTING ACTION
bone perforation

→ CLINICAL APPLICATION
to enlarge or to finalize the
implant site preparation; insert
with double irrigation to avoid
overheating (in the maxilla)

→ MODE → POWER

PIEZOSURGERY® touch
Implant

PIEZOSURGERY® 3
Implant Implant

PIEZOSURGERY® II
Bone 1

PIEZOSURGERY®
Boosted C



→ **CUTTING ACTION**
bone perforation

→ **CLINICAL APPLICATION**
to finalize the implant site preparation; insert with double irrigation to avoid overheating (in the maxilla)

→ **MODE** → **POWER**

PIEZOSURGERY® *touch*
Implant

PIEZOSURGERY® 3
Implant Implant

PIEZOSURGERY® II
Bone 1

PIEZOSURGERY®
Boosted C

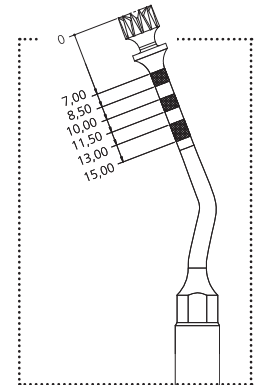

4 mm Ø implant site preparation insert

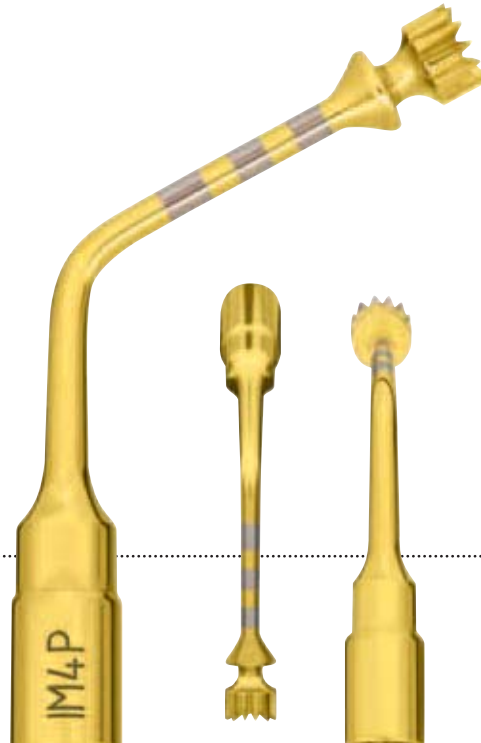
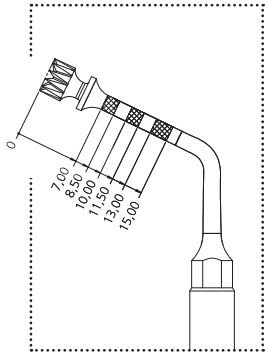

→ CUTTING ACTION

bone perforation

→ CLINICAL APPLICATION

to finalize the implant site preparation; insert with double irrigation to avoid overheating (in the maxilla)

→ MODE

→ POWER

PIEZOSURGERY® touch
Implant

PIEZOSURGERY® 3
Implant

Implant

PIEZOSURGERY® II
Bone

1

PIEZOSURGERY®
Boosted

C

→ **CUTTING ACTION**
micrometric osteotomy

→ **CLINICAL APPLICATION**
to optimize concentricity of
implant site preparation
between $\varnothing 2$ and $\varnothing 3$ mm

→ **MODE** → **POWER**

PIEZOSURGERY® *touch*
Implant

PIEZOSURGERY® 3
Implant Implant

PIEZOSURGERY® II
Bone 1

PIEZOSURGERY®
Boosted C

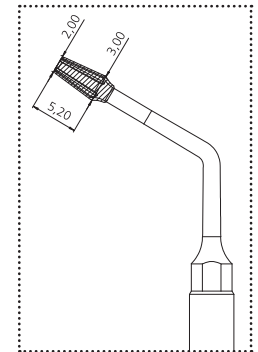
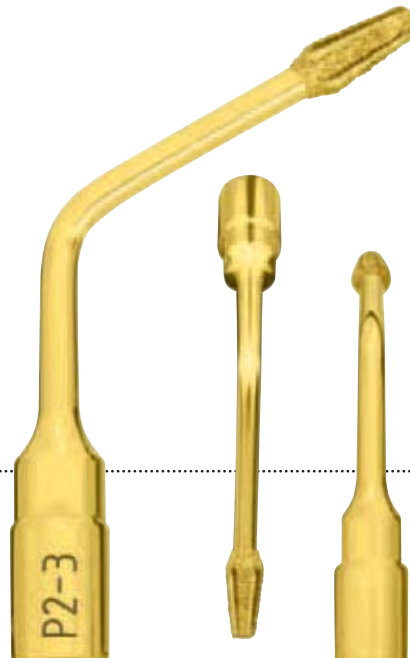

diamond grain size 150 μm



pilot implant site preparation insert

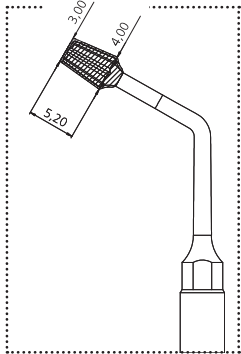

diamond grain size 150 µm

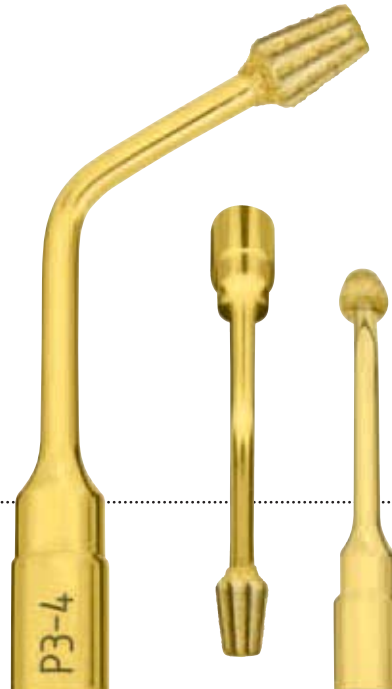

→ CUTTING ACTION
micrometric osteotomy

→ CLINICAL APPLICATION
to optimize concentricity of
implant site preparation
between $\varnothing 3$ and $\varnothing 4$ mm

→ MODE → POWER

PIEZOSURGERY® touch
Implant

PIEZOSURGERY® 3
Implant Implant

PIEZOSURGERY® II
Bone 1

PIEZOSURGERY®
Boosted C

→ BONE EXPANDERS

Dr. Sentineri's technique

→ DESCRIPTION

Only the initial part is threaded. When the smooth coronal part comes into contact with the corticalis, instead of penetrating into it, it displaces it, facilitating lateral expansion.

Usable with implantology micromotor or ratchet.

→ CLINICAL APPLICATION

- Technique for expanding the atrophic alveolar ridge
- Lateral bone condensation technique
- Alternative to the maxillary sinus elevation technique



→ AVAILABLE EXPANDERS

2.5 x 11.5

3.5 x 11.5

4.5 x 11.5

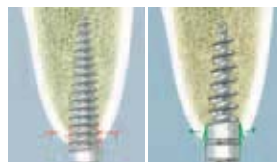

Conventional expander mectron expander



2.5 x 15



3.5 x 15



4.5 x 15

(\varnothing x length, in mm)

16 mm



→ ADR16

Long adapter
for ratchet

7 mm



→ ADR7

Short adapter
for ratchet

8 mm



→ ADM8

Adapter for
micromotor



→ RATCHET

→ SINUS PHYSIOLIFT®

→ DESCRIPTION

A new minimally invasive technique of maxillary sinus elevation by the crestal route using screw elevators and hydrodynamic pressure.

→ CLINICAL APPLICATION

- Elevation of the sinus membrane with micrometric precision by means of hydrodynamic pressure
- Watertight sinus elevator for hydrodynamic sinus lift
- Atraumatic technique not requiring the use of hammer and osteotome
- Implant site preparation using PIEZOSURGERY® – the sinus basal cortex is removed with minimal risk of perforating the Schneiderian membrane
- Multiple implant placement can be performed
- A flapless procedure can be performed in some cases

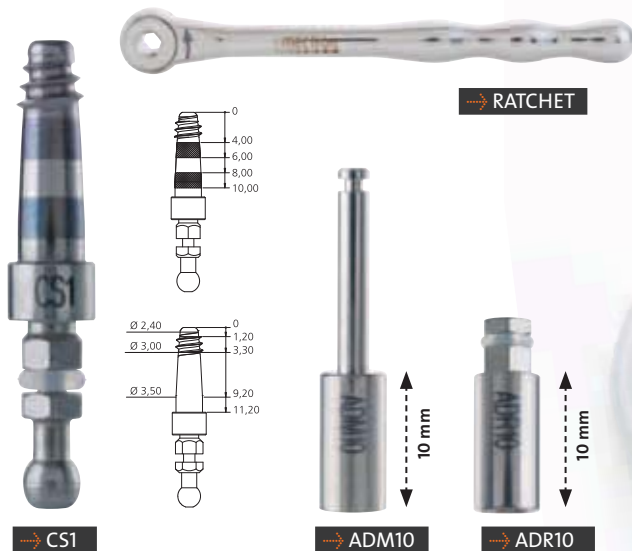

→ SINGLE IMPLANT SINUS LIFT



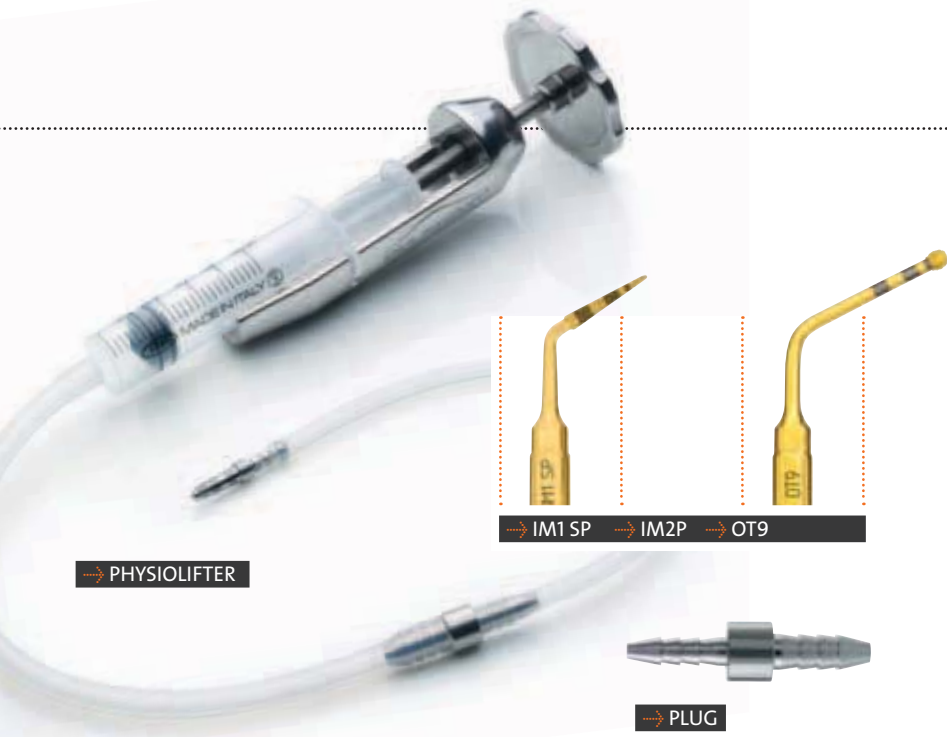

→ PHYSIOLIFTER

→ IM1 SP → IM2P → OT9

→ PLUG

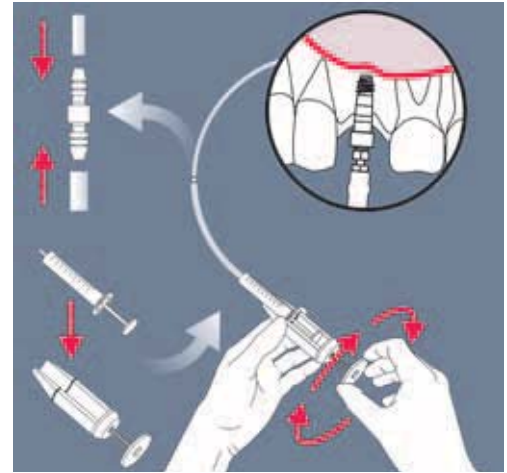

After preparation of the site with PIEZOSURGERY®, the CS1 elevator is introduced, and the tube connected to a syringe containing 3 ml of physiological saline solution is then inserted in the CS1. With the Sinus Physiolift® protocol, it is possible to elevate the Schneiderian membrane safely, controlling the pressure of the liquid by means of the attached Physiolifter device.

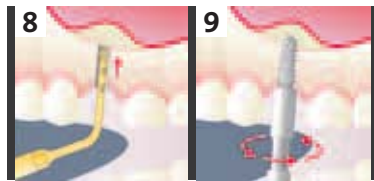

→ MULTIPLE
IMPLANT
SINUS LIFT



SINUS PHYSIOLIFT®

→ CUTTING ACTION

bone perforation

→ CLINICAL APPLICATION

initial osteotomy in sinus physiollift®
technique

→ MODE

PIEZOSURGERY® *touch*
Implant

PIEZOSURGERY® 3
Implant

PIEZOSURGERY® II
Bone

PIEZOSURGERY®
Boosted

→ POWER

Implant

1

C

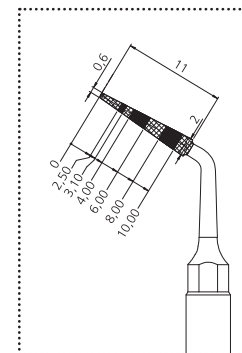
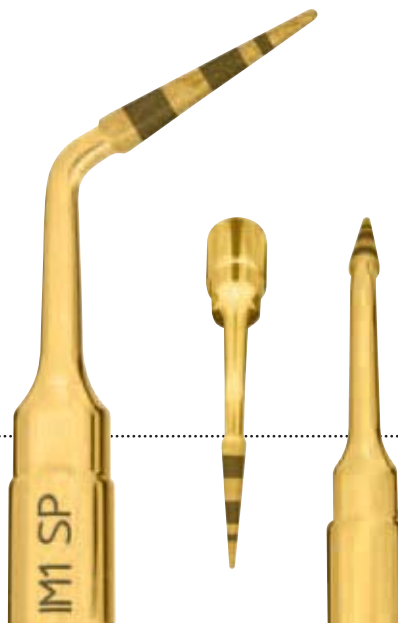

mini dental implant insert

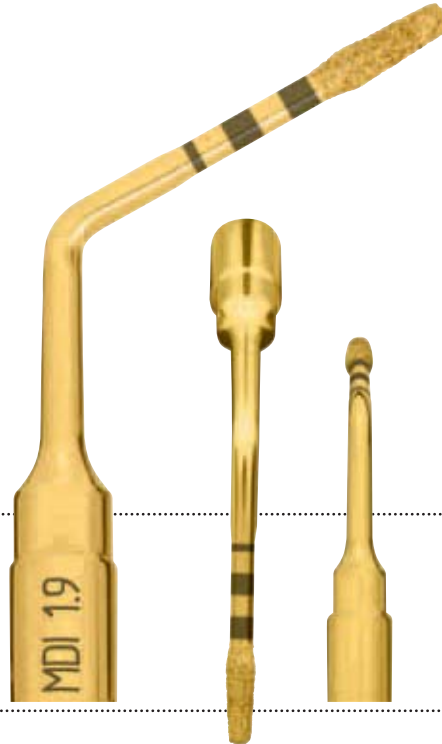
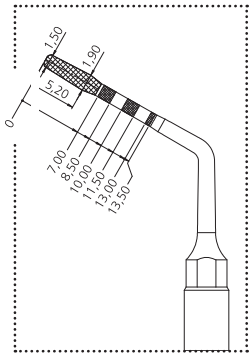

→ CUTTING ACTION

bone perforation

→ CLINICAL APPLICATION

osteotomy technique for mini implants
site preparation

→ MODE

→ POWER

PIEZOSURGERY® *touch*
Implant

PIEZOSURGERY® 3
Implant Implant

PIEZOSURGERY® II
Bone 1

PIEZOSURGERY®
Boosted C

MDI 2.2

mini dental implant insert

→ CUTTING ACTION

bone perforation

→ CLINICAL APPLICATION

osteotomy technique for mini implants
site preparation

→ MODE

PIEZOSURGERY® *touch*
Implant

PIEZOSURGERY® 3
Implant

PIEZOSURGERY® II
Bone

PIEZOSURGERY®
Boosted

→ POWER

Implant

1

C

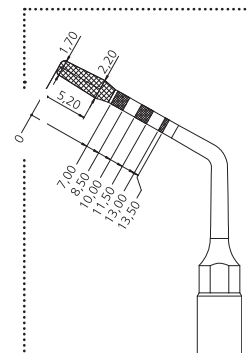
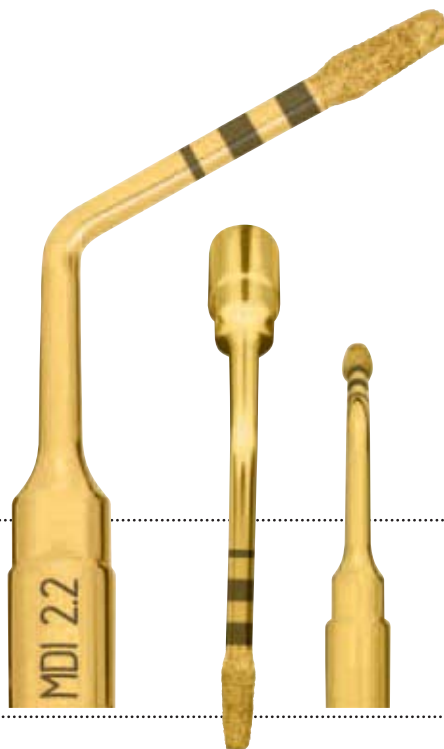

mini dental implant insert

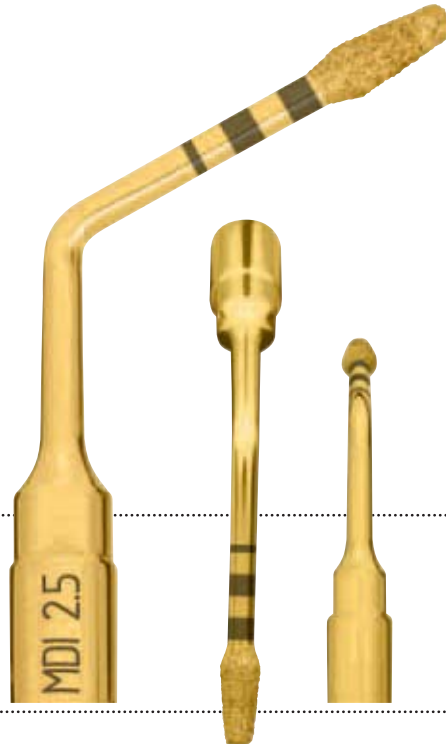
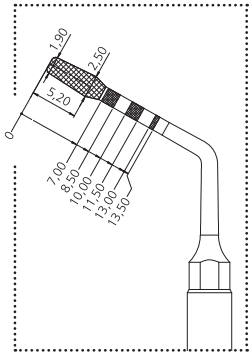

→ CUTTING ACTION

bone perforation

→ CLINICAL APPLICATION

osteotomy technique for mini implants
site preparation

→ MODE

→ POWER

PIEZOSURGERY® *touch*
Implant

PIEZOSURGERY® 3
Implant Implant

PIEZOSURGERY® II
Bone 1

PIEZOSURGERY®
Boosted C

→ CUTTING ACTION

micrometric osteotomy (about 1 mm)

→ CLINICAL APPLICATION

to finalize the osteotomy in proximity of soft tissue (for example: sinus membrane, vessel, alveolar nerve)

→ MODE

PIEZOSURGERY® *touch*
Cortical/Cancellous

PIEZOSURGERY® 3
Bone

PIEZOSURGERY® II
Bone

PIEZOSURGERY®
Boosted

→ POWER

Cortical/Spongious

1

C

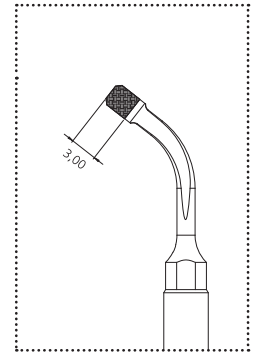
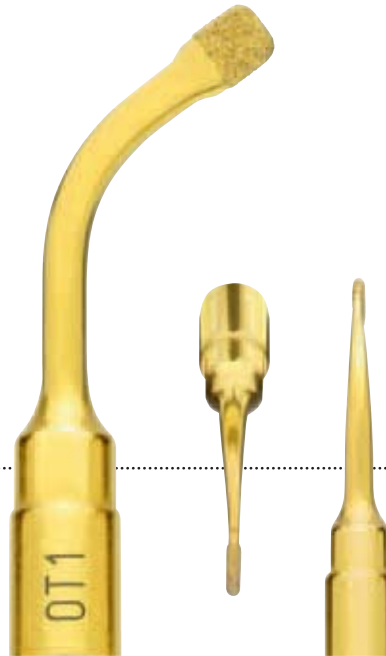

diamond grain size 91 µm

sinus bony window osteotomy insert

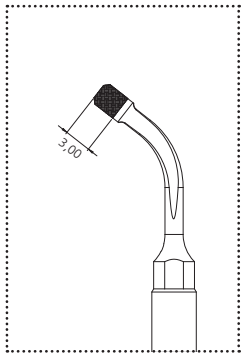

diamond grain size 126 μ m

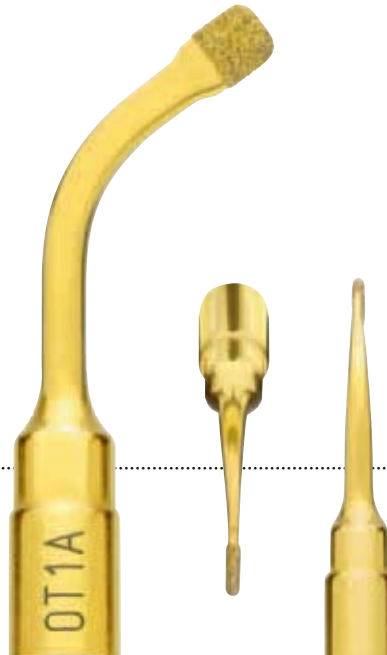

→ CUTTING ACTION

micrometric osteotomy (about 1 mm)

→ CLINICAL APPLICATION

to finalize the osteotomy in proximity of soft tissue (for example: sinus membrane, vessel, alveolar nerve)

→ MODE

→ POWER

PIEZOSURGERY® *touch*
Cortical/Cancellous

PIEZOSURGERY® 3
Bone

Cortical/Spongious

PIEZOSURGERY® II
Bone

1

PIEZOSURGERY®
Boosted

C

→ CUTTING ACTION

osteotomy

→ CLINICAL APPLICATION

osteotome of great precision
in anatomically thin structures
(for example, ridge expansion,
interdental corticotomies, non
traumatic nasal spina)

→ MODE

→ POWER

PIEZOSURGERY® *touch*
Cortical/Cancellous

PIEZOSURGERY® 3
Bone Cortical/Spongious

PIEZOSURGERY® II
Bone 1

PIEZOSURGERY®
Boosted C

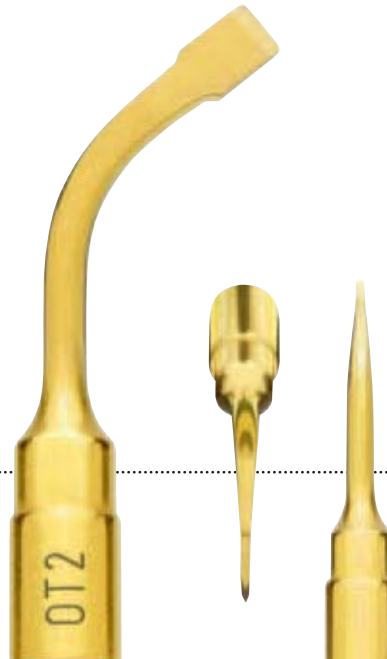



→ CUTTING ACTION
osteotomy

→ CLINICAL APPLICATION
mandibular corticotomy, block
harvesting, fragmenta osteotomy

→ MODE → POWER

PIEZOSURGERY® *touch*
Cortical/Cancellous

PIEZOSURGERY® 3
Bone Cortical/Spongious

PIEZOSURGERY® II
Bone 1

PIEZOSURGERY®
Boosted C

→ CUTTING ACTION

micrometric osteotomy (about 1 mm)

→ CLINICAL APPLICATION

to correct pilot osteotomy axis, to finalize the implant site preparation close to the alveolar nerve; sinus crestal approach technique

→ MODE

PIEZOSURGERY® touch
Cortical/Cancellous

PIEZOSURGERY® 3

Bone

→ POWER

Cortical/Spongious

PIEZOSURGERY® II

Bone

1

PIEZOSURGERY®

Boosted

C

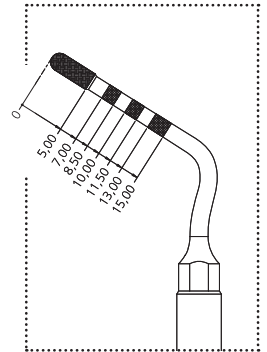

diamond grain size 151 µm



osteoplasty and osteotomy insert

→ OT5 – OT5A – OT5B

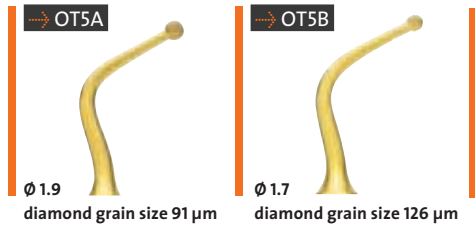

→ CUTTING ACTION
micrometric osteotomy or osteoplasty

→ CLINICAL APPLICATION
non-traumatic, to finalize the osteotomy or osteoplasty on thin bone and/or near delicate anatomic structures

→ MODE → POWER

PIEZOSURGERY® *touch*
Cortical/Cancellous

PIEZOSURGERY® 3
Bone Cortical/Spongious

PIEZOSURGERY® II
Bone 1

PIEZOSURGERY®
Boosted C

Ø 1,7 – diamond grain size 91 µm

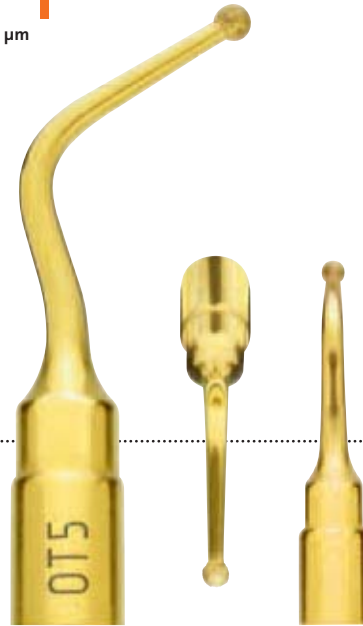

→ CUTTING ACTION

high effectiveness osteotomy

→ CLINICAL APPLICATION

osteotomy of large bone sections during maxillofacial surgery

→ MODE

PIEZOSURGERY® *touch*
Cortical/Cancellous

→ POWER

PIEZOSURGERY® 3
Bone Cortical/Spongious

PIEZOSURGERY® II
Bone 1

PIEZOSURGERY®
Boosted C



principal micro-saw 0.55 mm

OT7-OT7A

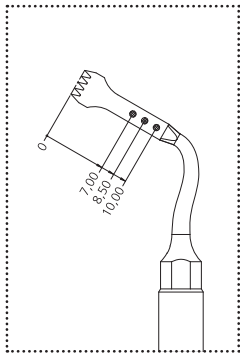

thickness 0.55 mm



→ CUTTING ACTION
high effectiveness osteotomy

→ CLINICAL APPLICATION
all the osteotomy technique
in maxilla and mandible

- ridge expansion
- corticotomy technique
- bone block grafting

→ MODE → POWER

PIEZOSURGERY® touch
Cortical/Cancellous

PIEZOSURGERY® 3
Bone Cortical/Spongious

PIEZOSURGERY® II
Bone 1

PIEZOSURGERY® Boosted
C



OT7S-4

special micro-saw 0.35 mm (4 teeth)

→ CUTTING ACTION

high effectiveness and precision osteotomy

→ CLINICAL APPLICATION

very thin osteotomy, corticotomy for orthodontic microsurgery technique, root separation in dental extraction technique and periodontal surgery

→ MODE

PIEZOSURGERY® *touch*
Special*

PIEZOSURGERY® 3
Bone

PIEZOSURGERY® II
Bone

PIEZOSURGERY®
Boosted

→ POWER

Special*

Special*

C

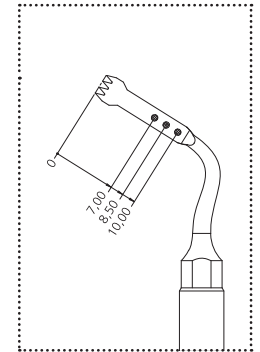

*Maximum power permitted

special micro-saw 0.35 mm (3 teeth)

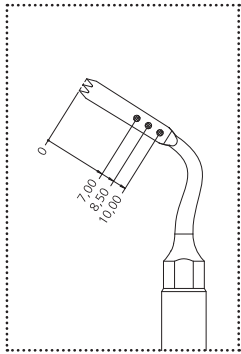

→ CUTTING ACTION

high precision osteotomy

→ CLINICAL APPLICATION

very thin and small osteotomy and corticotomy technique for orthodontic microsurgery, root fraction technique for dental extraction maneuver

→ MODE

→ POWER

PIEZOSURGERY® *touch*
Special*

PIEZOSURGERY® 3
Bone Special*

PIEZOSURGERY® II
Bone Special*

PIEZOSURGERY®
Boosted C

OT7-20

micro-saw, length 20 mm

→ CUTTING ACTION

high effectiveness osteotomy

→ CLINICAL APPLICATION

ridge expansion technique, bone block grafting (from chin/mandible ramus), Le Fort I osteotomy, bilateral sagittal split osteotomy

→ MODE

PIEZOSURGERY® *touch*
Cortical/Cancellous

PIEZOSURGERY® 3

Bone

PIEZOSURGERY® II

Bone

PIEZOSURGERY®

Boosted

→ POWER

Cortical/Spongious

1

C



tight up this insert only with torque wrench K8

→ OT7-20 SET

The set consists of the insert OT7-20 and the torque wrench K8

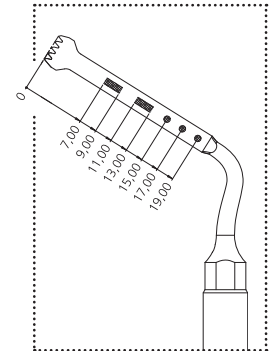

thickness 0.6 mm

angled micro-saw 0.6 mm

OT8R – OT8L

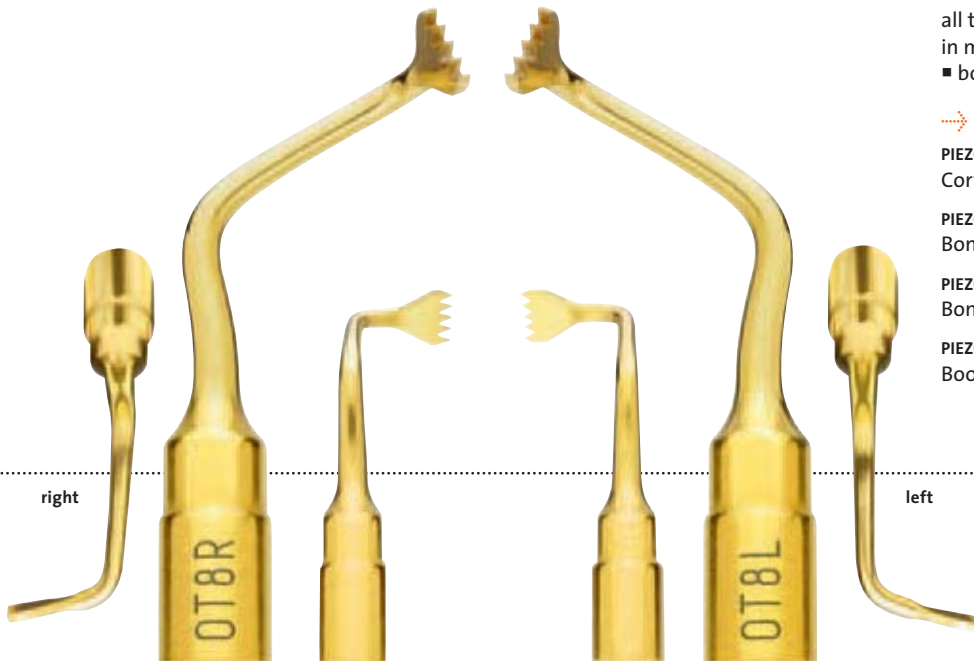

→ CUTTING ACTION

horizontal osteotomy

→ CLINICAL APPLICATION

all the osteotomy technique
in maxilla and mandible
■ bone block grafting

→ MODE

→ POWER

PIEZOSURGERY® *touch*
Cortical/Cancellous

PIEZOSURGERY® 3
Bone

Cortical/Spongious

PIEZOSURGERY® II
Bone

1

PIEZOSURGERY®
Boosted

C

→ CUTTING ACTION

micrometric osteotomy or osteoplasty

→ CLINICAL APPLICATION

to finalize the osteotomy or osteoplasty near delicate anatomic structures; removal of the sinus basal cortex in Sinus Physiolift® procedure

→ MODE

PIEZOSURGERY® touch
Cortical/Cancellous

PIEZOSURGERY® 3
Bone

PIEZOSURGERY® II
Bone

PIEZOSURGERY®
Boosted

→ POWER

Cortical/Spongious

1

C

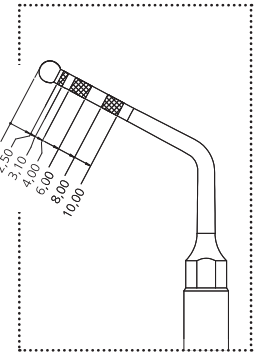

Ø 2.4 – diamond grain size 151 µm

→ CUTTING ACTION

high efficiency bone osteoplasty

→ CLINICAL APPLICATION

bone remodelling and harvesting of bone chips

→ MODE

PIEZOSURGERY® *touch*
Cortical/Cancellous

PIEZOSURGERY® 3
Bone

PIEZOSURGERY® II
Bone

PIEZOSURGERY®
Boosted

→ POWER

Cortical/Spongious

1

C





→ **CUTTING ACTION**

osteoplasty

→ **CLINICAL APPLICATION**

bone osteotomy, remodelling and removal of inflammatory tissue

→ **MODE**

→ **POWER**

PIEZOSURGERY® *touch*
Cortical/Cancellous

PIEZOSURGERY® 3
Bone

Cortical/Spongious

PIEZOSURGERY® II
Bone

1

PIEZOSURGERY®
Boosted

C

→ OP3 – OP3A

principal osteoplasty insert

→ CUTTING ACTION

universal osteoplasty

→ CLINICAL APPLICATION

periodontal osteotomy, crown lengthening, bone chips harvesting, inflammatory tissue removal (cyst, etc.)

→ MODE

PIEZOSURGERY® touch
Cortical/Cancellous

PIEZOSURGERY® 3
Bone

PIEZOSURGERY® II
Bone

PIEZOSURGERY®
Boosted

→ POWER

Cortical/Spongious

1

C



crown lengthening file

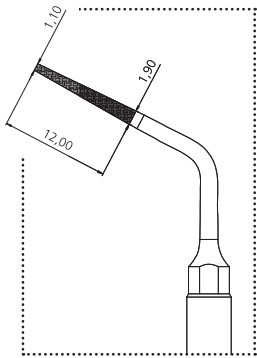

diamond grain size 126 µm

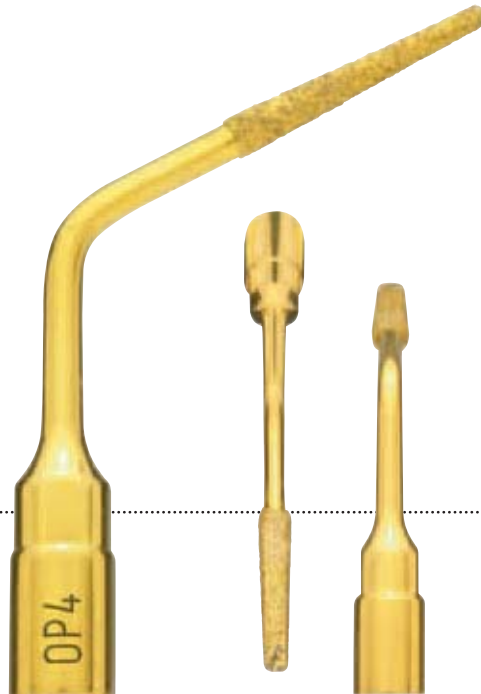

→ CUTTING ACTION

micro-osteoplasty

→ CLINICAL APPLICATION

interproximal osteoplasty
and root planing

→ MODE

→ POWER

PIEZOSURGERY® *touch*
Cortical/Cancellous

PIEZOSURGERY® 3
Bone Cortical/Spongious

PIEZOSURGERY® II
Bone 1

PIEZOSURGERY®
Boosted C

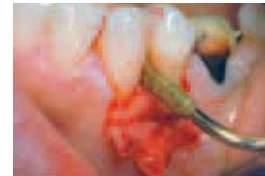

→ **CUTTING ACTION**
scaling and microdebridement

→ **CLINICAL APPLICATION**
root debridement and root planing
during resective and regenerative
periodontal surgery

→ **MODE** → **POWER**

PIEZOSURGERY® *touch*
Perio

PIEZOSURGERY® 3
Root Perio

PIEZOSURGERY® II
Root Perio

PIEZOSURGERY®
High 2-3

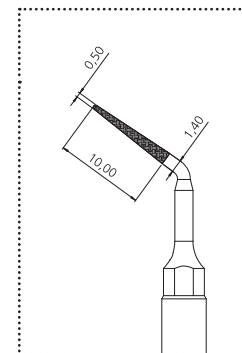

diamond grain size 30 µm

micro-root-preparation

OP6 – OP6A



OP6A

diamond grain size 30 µm

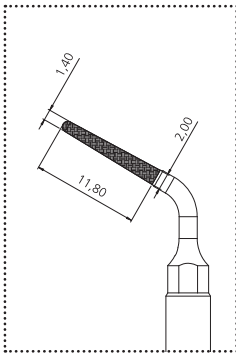

diamond grain size 126 µm



→ CUTTING ACTION
micro-root preparation

→ CLINICAL APPLICATION
root preparation in periodontal surgery

→ MODE → POWER

PIEZOSURGERY® touch
Perio

PIEZOSURGERY® 3
Root Perio

PIEZOSURGERY® II
Root Perio

PIEZOSURGERY®
High 2-3



→ CUTTING ACTION

micro-osteotomy

→ CLINICAL APPLICATION

peri-apical maxillary bone
osteotomy access, inflammatory
tissue removal

→ MODE

PIEZOSURGERY® *touch*
Cortical/Cancellous

PIEZOSURGERY® 3
Bone

PIEZOSURGERY® II
Bone

PIEZOSURGERY®
Boosted

→ POWER

Cortical/Spongious

1

C

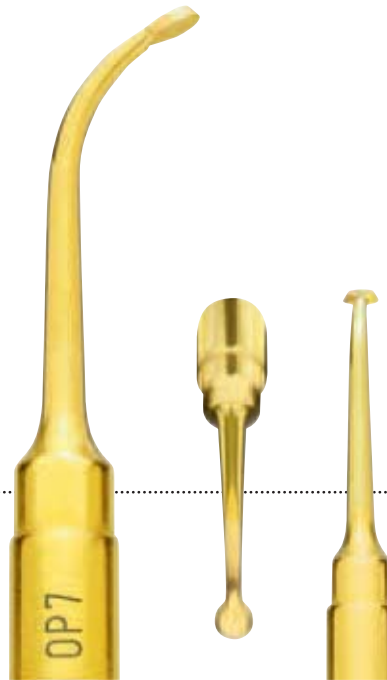

sinus membrane separator

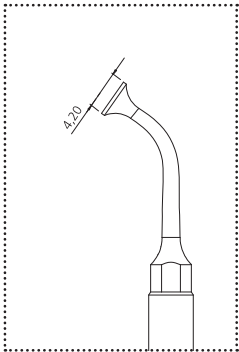

→ CUTTING ACTION

schneiderian membrane
separation from bony walls

→ CLINICAL APPLICATION

separation of the sinus membrane,
2 mm around the frame of bony window

→ MODE

→ POWER

PIEZOSURGERY® *touch*
Endo*

PIEZOSURGERY® 3
Root

Endo*

PIEZOSURGERY® II
Root

Endo*

PIEZOSURGERY®
Low

1



*Maximum power permitted

→ CUTTING ACTION

non-cutting elevator of the sinus membrane

→ CLINICAL APPLICATION

separation of the sinus membrane in internal zones

→ MODE

→ POWER

PIEZOSURGERY® *touch*
Endo*

PIEZOSURGERY® 3
Root Endo*

PIEZOSURGERY® II
Root Endo*

PIEZOSURGERY®
Low 1

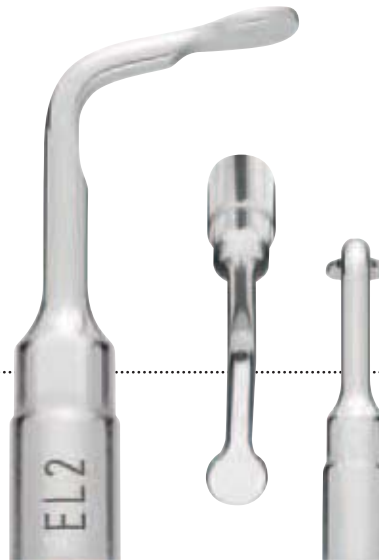

*Maximum power permitted

sinus membrane separator angled at 130°



→ CUTTING ACTION

non-cutting elevator of the sinus membrane

→ CLINICAL APPLICATION

separation of the sinus membrane in internal zones

→ MODE

→ POWER

PIEZOSURGERY® *touch*
Endo*

PIEZOSURGERY® 3
Root

Endo*

PIEZOSURGERY® II
Root

Endo*

PIEZOSURGERY®
Low

1

*Maximum power permitted

→ CUTTING ACTION
efficient canal cleaning

→ CLINICAL APPLICATION
apical root debridement

→ MODE → POWER

PIEZOSURGERY® *touch*
Endo*

PIEZOSURGERY® 3
Root Endo*

PIEZOSURGERY® II
Root Endo*

PIEZOSURGERY®
Low 1

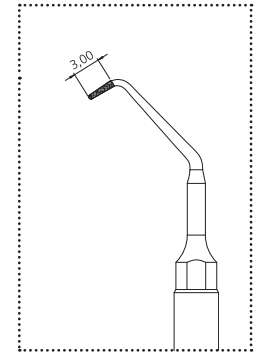
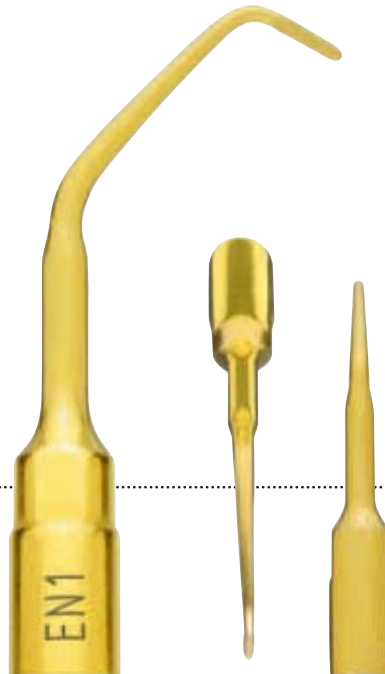

diamond grain size 30 µm

*Maximum power permitted

smooth endo apical debrider 3 mm



→ CUTTING ACTION

gentle canal cleaning

→ CLINICAL APPLICATION

gentle apical root debridement

→ MODE

→ POWER

PIEZOSURGERY® *touch*
Endo*

PIEZOSURGERY® 3
Root

Endo*

PIEZOSURGERY® II
Root

Endo*

PIEZOSURGERY®
Low

1

*Maximum power permitted

→ CUTTING ACTION
efficient canal cleaning

→ CLINICAL APPLICATION
apical root debridement

→ MODE → POWER

PIEZOSURGERY® *touch*
Endo*

PIEZOSURGERY® 3
Root Endo*

PIEZOSURGERY® II
Root Endo*

PIEZOSURGERY®
Low 1

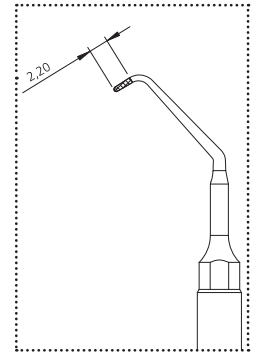

diamond grain size 30 µm

*Maximum power permitted

smooth endo apical debrider 2.2 mm

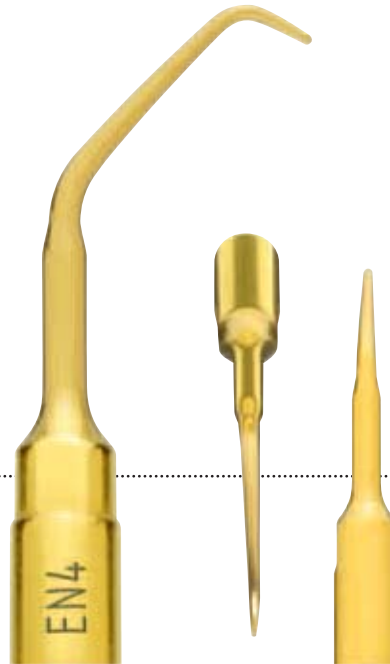

→ CUTTING ACTION

gentle canal cleaning

→ CLINICAL APPLICATION

gentle apical root debridement

→ MODE

→ POWER

PIEZOSURGERY® *touch*
Endo*

PIEZOSURGERY® 3
Root

Endo*

PIEZOSURGERY® II
Root

Endo*

PIEZOSURGERY®
Low

1

*Maximum power permitted

→ CUTTING ACTION
efficient canal cleaning

→ CLINICAL APPLICATION
apical root debridement

→ MODE → POWER

PIEZOSURGERY® touch
Endo*

PIEZOSURGERY® 3
Root Endo*

PIEZOSURGERY® II
Root Endo*

PIEZOSURGERY®
Low 1

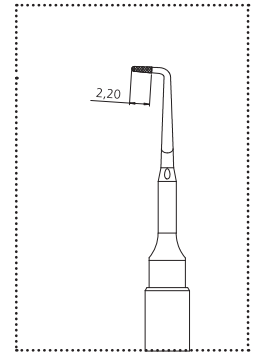
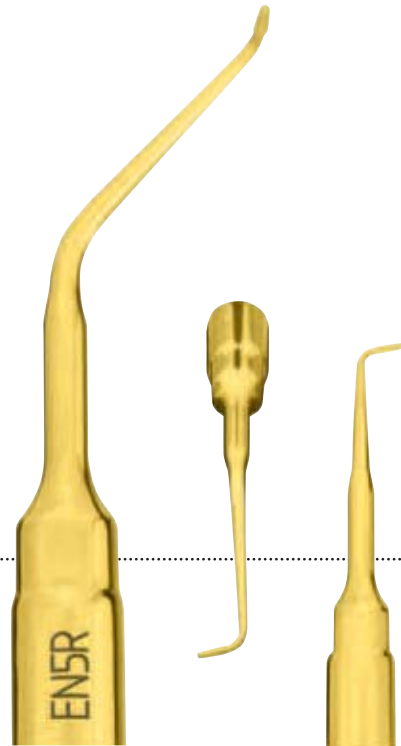

diamond grain size 30 µm

*Maximum power permitted

left angled, diamond-coated endo apical debrider 2.2 mm

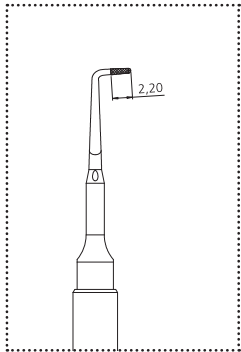

diamond grain size 30 µm

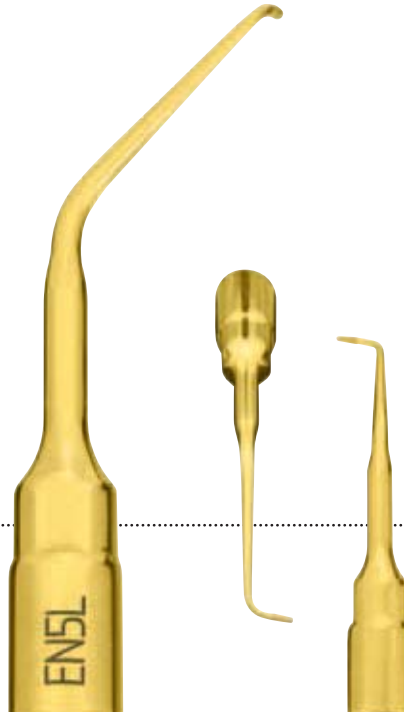

→ CUTTING ACTION
efficient canal cleaning

→ CLINICAL APPLICATION
apical root debridement

→ MODE → POWER

PIEZOSURGERY® touch
Endo*

PIEZOSURGERY® 3
Root

Endo*

PIEZOSURGERY® II
Root

Endo*

PIEZOSURGERY®
Low

1

*Maximum power permitted

→ CUTTING ACTION

efficient canal cleaning

→ CLINICAL APPLICATION

apical root debridement

→ MODE

→ POWER

PIEZOSURGERY® *touch*

Endo*

PIEZOSURGERY® 3

Root

Endo*

PIEZOSURGERY® II

Root

Endo*

PIEZOSURGERY®

Low

1

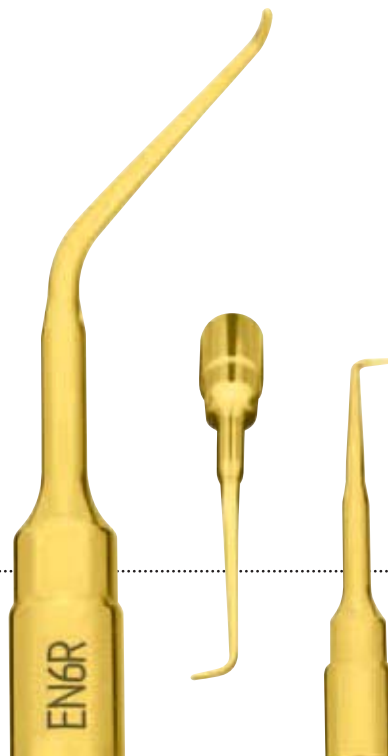

left angled, smooth endo apical debrider 2.2 mm

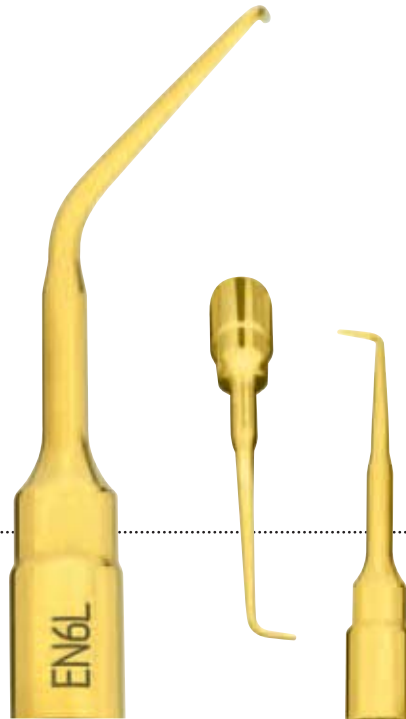

→ CUTTING ACTION
efficient canal cleaning

→ CLINICAL APPLICATION
apical root debridement

→ MODE → POWER

PIEZOSURGERY® *touch*
Endo*

PIEZOSURGERY® 3
Root Endo*

PIEZOSURGERY® II
Root Endo*

PIEZOSURGERY®
Low 1

*Maximum power permitted

→ CUTTING ACTION

root osteoplasty

→ CLINICAL APPLICATION

to cut off the ankylosis, root fraction techniques

→ MODE

PIEZOSURGERY® *touch*
Cortical/Cancellous

PIEZOSURGERY® 3

Bone

PIEZOSURGERY® II

Bone

PIEZOSURGERY®

Boosted

→ POWER

Cortical/Spongious

1

C



angled extraction scalpel

EX2 – EX3

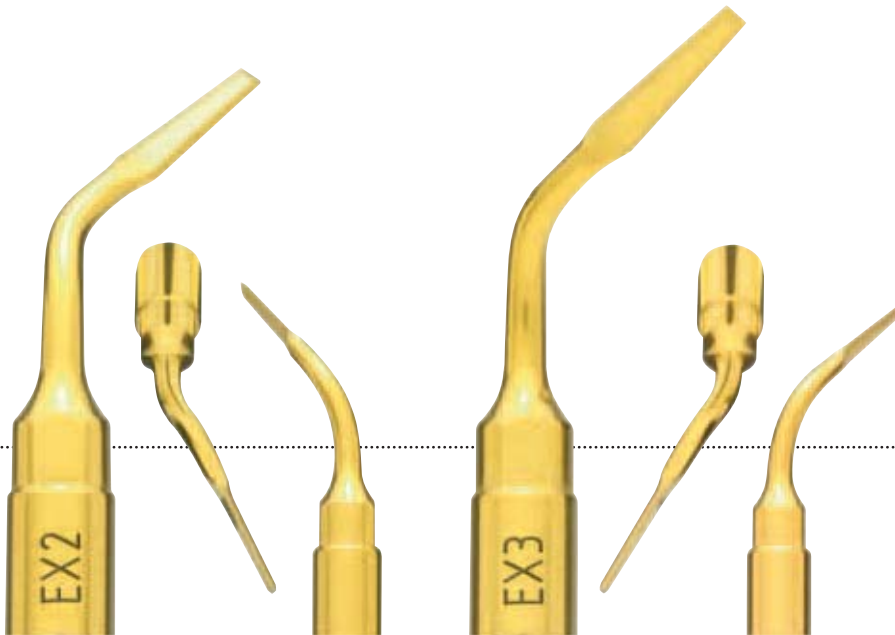

→ CUTTING ACTION

root osteoplasty

→ CLINICAL APPLICATION

analogue to EX1 in the posterior regions

→ MODE

→ POWER

PIEZOSURGERY® *touch*
Cortical/Cancellous

PIEZOSURGERY® 3

Bone

Cortical/Spongious

PIEZOSURGERY® II

Bone

1

PIEZOSURGERY®

Boosted

C

→ CUTTING ACTION

gentle scaling

→ CLINICAL APPLICATION

root scaling

→ MODE

→ POWER

PIEZOSURGERY® *touch*

Perio

PIEZOSURGERY® 3

Root

Perio

PIEZOSURGERY® II

Root

Perio

PIEZOSURGERY®

High

2-3

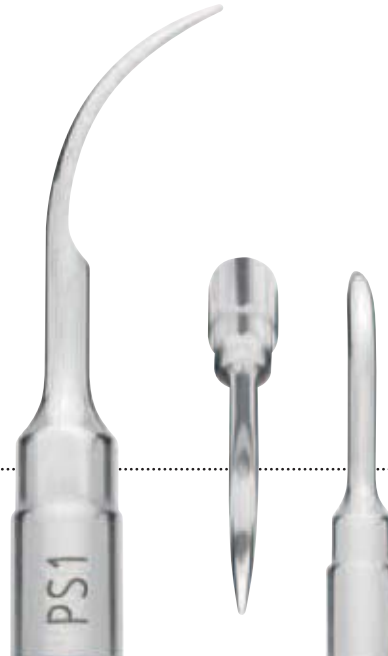

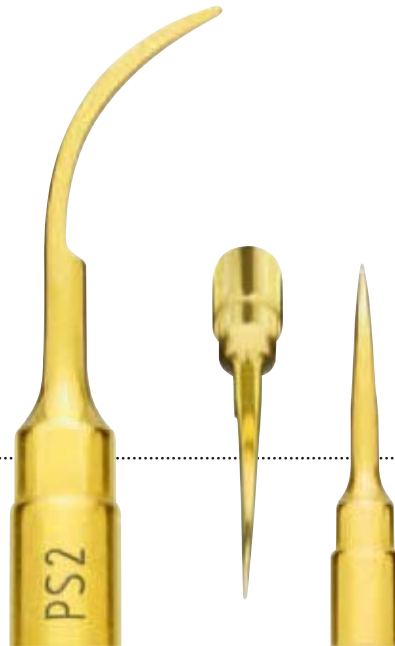

→ CUTTING ACTION

powerful scaling

→ CLINICAL APPLICATION

scaling and inflammatory tissue removal
fractured root apex extraction

→ MODE

→ POWER

PIEZOSURGERY® *touch*
Perio

PIEZOSURGERY® 3
Root Perio

PIEZOSURGERY® II
Root Perio

PIEZOSURGERY®
High 2-3



→ CUTTING ACTION

gentle scaling

→ CLINICAL APPLICATION

root scaling

→ MODE

→ POWER

PIEZOSURGERY® *touch*

Perio

PIEZOSURGERY® 3

Root

Perio

PIEZOSURGERY® II

Root

Perio

PIEZOSURGERY®

High

2-3



principal root planing insert



→ CUTTING ACTION
root surface micro-smoothing

→ CLINICAL APPLICATION
root planing

→ MODE → POWER

PIEZOSURGERY® *touch*
Perio

PIEZOSURGERY® 3
Root Perio

PIEZOSURGERY® II
Root Perio

PIEZOSURGERY®
High 2-3

→ CUTTING ACTION

root surface micro-smoothing

→ CLINICAL APPLICATION

gentle subgingival concretions removal

→ MODE

→ POWER

PIEZOSURGERY® *touch*

Perio

PIEZOSURGERY® 3

Root

Perio

PIEZOSURGERY® II

Root

Perio

PIEZOSURGERY®

High

2-3

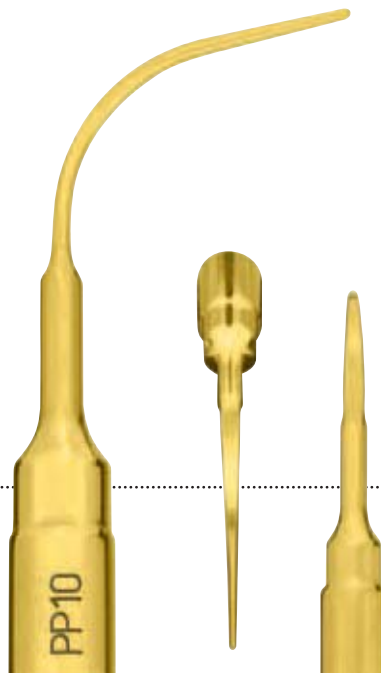

left and right angled, gentle perio anatomic insert

PP11 – PP12

→ CUTTING ACTION

root surface micro-smoothing

→ CLINICAL APPLICATION

gentle subgingival concretions removal

→ MODE

→ POWER

PIEZOSURGERY® touch

Perio

PIEZOSURGERY® 3

Root

Perio

PIEZOSURGERY® II

Root

Perio

PIEZOSURGERY®

High

2-3

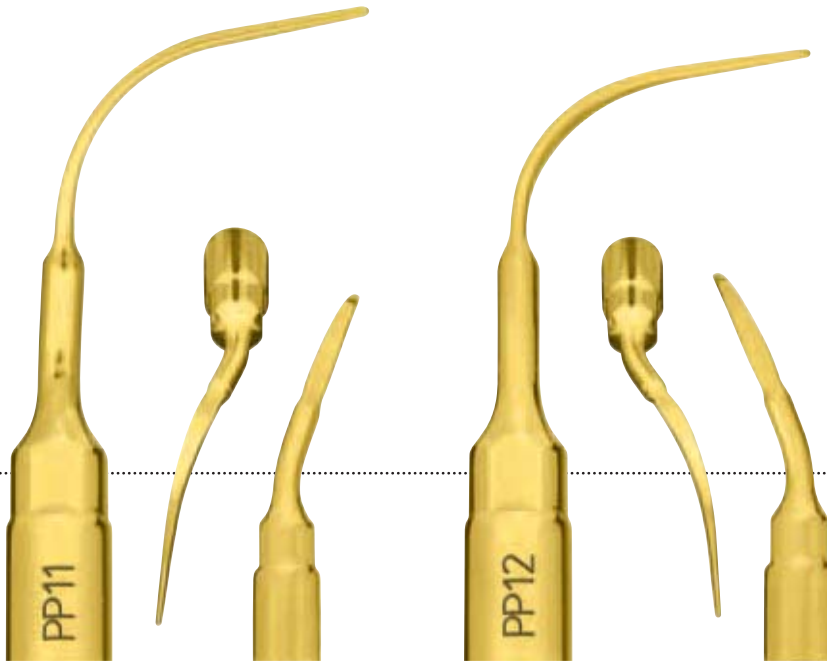

ICP + IC1

implant cleaning

→ CUTTING ACTION

gentle and safe cleaning action of the implant surface

→ CLINICAL APPLICATION

efficient and soft cleaning of implants and restorations

→ MODE

PIEZOSURGERY® touch
Perio

PIEZOSURGERY® 3
Root

PIEZOSURGERY® II
Root

PIEZOSURGERY®
High

→ POWER

Perio

Perio

2-3

→ IMPLANT CLEANING SET P

The set consists of a tipholder ICP and 5 tips IC1



→ ICP

→ IC1

implant cleaning tip IC1 can be easily tightened without special tools and is fully autoclavable

preparation and finishing of subgingival margins

→ CROWN PREP TIPS



→ CUTTING ACTION

micro-smoothing

→ CLINICAL APPLICATION

ultrasonic finishing of the cervical margin

→ MODE

→ POWER

PIEZOSURGERY® touch

Perio/Special

PIEZOSURGERY® 3

Bone	Special
Root	Perio

PIEZOSURGERY® II

Bone	Special
Root	Perio

PIEZOSURGERY®

Boosted	A
High	2-3

→ LENGTH 10 MM

→ DIAMOND COATING

diameter	D120	D90	D60
1.2 mm		TA12D90	TA12D60
1.4 mm	TA14D120	TA14D90	TA14D60
1.6 mm	TA16D120	TA16D90	TA16D60

ENZYMEC

enzymatic detergent

- enzymatic solution for efficient removal of organic residue
- specifically dedicated to the “clean” function of all PIEZOSURGERY® devices
- works perfectly in ultrasonic cleaning tanks
- easy handling thanks to the dosage measuring cap

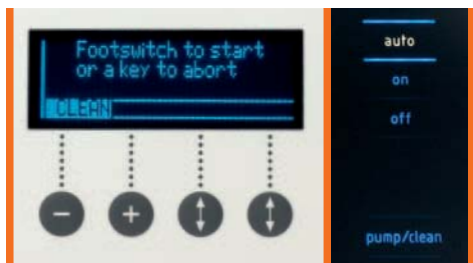

→ PIEZOSURGERY® – MORE THAN 12 YEARS OF SUCCESSFUL SCIENTIFIC RESEARCH



→ METHOD PIEZOSURGERY®: EVIDENCED-BASED

With over 12 years of successful clinical research, the original PIEZOSURGERY® method is the only one supported by more than 100 clinical and scientific studies. An updated list of publications can be found at www.mectron.com. Abstract collections are also available for download.

→ WWW.PIEZOSURGERYACADEMY.COM – THE SCIENTIFIC INFO PLATFORM



Tomaso Vercellotti, MD, DDS

→ THE INVENTION

„The PIEZOSURGERY® has been developed in order to overcome the limits of precision and intra-operative safety existing in traditional bone cutting inserts.“

→ PIEZOSURGERY® ACADEMY

The website of the PIEZOSURGERY® academy, an independent institute for the advancement of the original PIEZOSURGERY® method. To find out about the possibilities of PIEZOSURGERY®, join one of the many seminars which are held in different languages.



INTERNATIONAL
Piezosurgery Academy®

SPARE PARTS



handpiece,
complete
with cord



handpiece holder with LED-handpiece



protection foils



peristaltic pump



torque wrench K8

CE
0476

→ COMMON SPARE PARTS

→ ITEM/REFERENCE NUMBER	
surgical tray	02900041
torque wrench K8	02900109
irrigation set	03230006
PIEZOSURGERY® insert box	02900111
insert tray	02900037
bone expander tray	02900107
implant insert tray	02900108
bag support rod	01380002

→ PIEZOSURGERY® touch

→ ITEM/REFERENCE NUMBER	
LED-handpiece, complete with cord	03120134
handpiece holder	02900105
mobile handpiece holder	03110015
kit of 8 tubes for pump	02900104
bone grafting kit (liquid flow rate reducer)	02900106
protection foils (pack of 5 sterile pieces)	03230010
footswitch	02900102

→ PIEZOSURGERY® I, II AND 3

→ ITEM/REFERENCE NUMBER	
handpiece, complete with cord	03120023
handpiece holder (PSII + 3)	02900040
kit of 8 tubes for pump	02900039
tube-tube connector	00680027
footswitch (PSI + II)	02900020
footswitch (PS3)	02900078
peristaltic pump	03210006

→ WARNINGS

→ DIAMOND-COATED INSERTS

When the diamond chips wear out a reduction in cutting capacity and a consequent increase in temperature may occur. Use these inserts for a maximum of ten applications.

→ CUTTING INSERTS

When the nitriding wears out the cutting edge loses efficiency and a re-sharpening is unadvisable due to its limited life-span.

→ MEMBRANE SEPARATORS

For a greater life-span it is recommended to use it on low power.
Boosted or high power can be useful if there are residual bony edges to be removed.

REFERENCE NUMBERS

→ ITEM/REFERENCE NUMBER

basic kit	01520001
sinus lift kit	01520002
implant prep kit	01520008
implant prep kit pro	01520011
implant prep kit starter	01520017
mini implant prep kit	01520016
osteotomy kit	01520010
periodontal kit	01520004
extraction kit	01520003
retro surgical kit	01520005
bone expander kit	03770001
bone expander kit pro	03770002
bone expander kit pro s	03770005
sinus physiolift® basic kit	03770003
sinus physiolift® pro kit	03770004
insert IM15	03510019
PIN IM1	03740002
PIN IM15	03740007
PIN 2-2.4	03740003
PIN 2-3	03740001
insert IM1 AL	03510010

→ ITEM/REFERENCE NUMBER

PIN IM1 AL	03740004
PIN 2-2.4 AL	03740005
PIN 2-3 AL	03740006
insert IM2A	03510001
insert IM2A-15	03510015
insert IM2P	03510002
insert IM2P-15	03510016
insert IM3A	03510003
insert IM3A-15	03510017
insert IM3P	03510004
insert IM3P-15	03510018
insert IM4A	03510005
insert IM4P	03510006
insert P2-3	03510020
insert P3-4	03510021
expander 2.5 x 11,5	03780001
expander 3.5 x 11,5	03780003
expander 4.5 x 11,5	03780005
expander 2.5 x 15	03780002
expander 3.5 x 15	03780004
expander 4.5 x 15	03780006

→ ITEM/REFERENCE NUMBER

ADM8	03790001
ADR7	03790002
ADR16	03790003
ratchet	02270005
crestal sinus elevator CS1	03920001
physiolifter	02900097
ADM10	03790004
ADR10	03790005
silicone tube with tube-tube connector	02900098
complete sealed tube	02900099
insert tray physiolift® (small)	02900100
insert tray physiolift® (large)	02900101
insert IM1 SP	03510011
insert MDI 1.9	03510012
insert MDI 2.2	03510013
insert MDI 2.5	03510014
insert OT1A	03370008
insert OT2	03370002
insert OT3	03370003
insert OT4	03370004
insert OT5	03370005

→ ITEM/REFERENCE NUMBER

insert OT5A	03370009
insert OT5B	03370010
insert OT6	03370006
insert OT7	03370007
insert OT7A	03370011
insert OT7S-4	03370014
insert OT7S-3	03370015
insert OT7-20	03370017
OT7-20 set (OT7-20 and K8)	02900103
insert OT8R	03370012
insert OT8L	03370013
insert OT9	03370016
insert OP1	03380001
insert OP2	03380002
insert OP3	03380003
insert OP3A	03380011
insert OP4	03380004
insert OP5	03380005
insert OP6	03380006
insert OP6A	03380010
insert OP7	03380007

→ ITEM/REFERENCE NUMBER

insert EL1	03390001
insert EL2	03390002
insert EL3	03390003
insert EN1	02170001
insert EN2	02170002
insert EN3	02170005
insert EN4	02170006
insert EN5R	02170007
insert EN5L	02170008
insert EN6R	02170009
insert EN6L	02170010
insert EX1	03400001
insert EX2	03400002
insert EX3	03400003
insert PS1	03180001
insert PS2	03180003
insert PS6	03180005
insert PP1	03180002
insert PP10	03180006
insert PP11	03180007
insert PP12	03180008

→ ITEM/REFERENCE NUMBER

tipholder ICP	03570003
tip IC1 (5 pieces)	02900112
implant cleaning set P (ICP and 5 x IC1)	01520020
crown prep kit PS (DB2, AB1 and K7)	02160010
tipholder DB2	03570002
key AB1	03580001
dynamometric wrench K7	02900081
crown prep tip TA12D60	03590001
crown prep tip TA14D60	03590002
crown prep tip TA16D60	03590003
crown prep tip TA12D90	03590004
crown prep tip TA14D90	03590005
crown prep tip TA16D90	03590006
crown prep tip TA14D120	03590007
crown prep tip TA16D120	03590008
Enzymec bottle (1 liter)	03900001
Enzymec 4-bottle pac (4 liter)	03900002

→ IN 1997 WE INVENTED PIEZOELECTRIC
BONE SURGERY. NOW WE DID IT AGAIN.
THE NEW MECTRON PIEZOSURGERY® *touch*

www.mectron.com – mectron@mectron.com

mectron s.p.a., via Loreto 15/A, 16042 Carasco (Ge), Italia, tel +39 0185 35361, fax +39 0185 351374



PIEZOSURGERY®

All prices are meant to be subject to VAT as legally applicable. We reserve the right to make technical changes and changes in the scope of the supply. No liability can be accepted for errors.

© Copyright mectron S.p.A., Carasco, Italy
All rights reserved. Texts, pictures and graphics of mectron brochures are protected by copyright and other protection laws. Without written approval of mectron S.p.A. the contents may not be copied, distributed, changed or made available to third parties for commercial purposes.